

12100-22 INSTALL GUIDE

1. Components

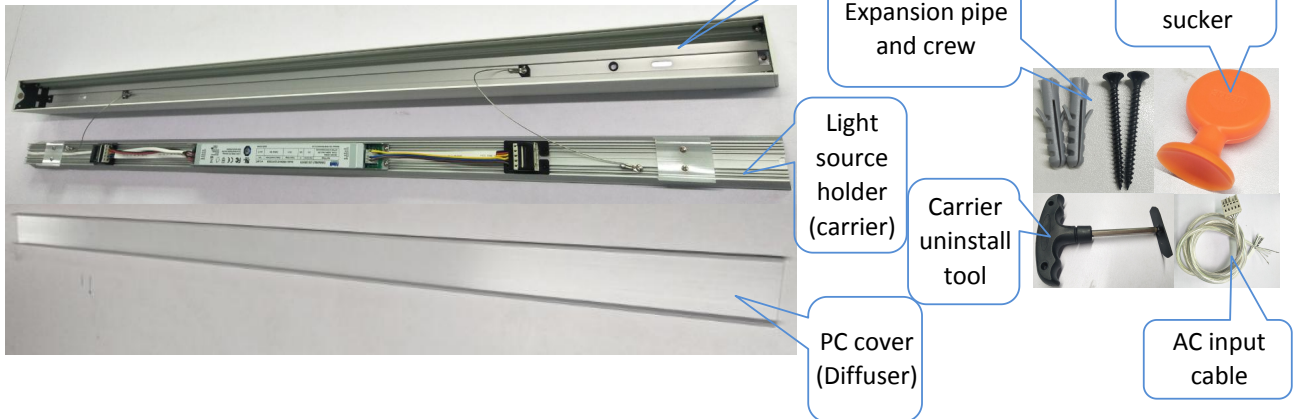

2. Installation

A. Ceiling mounting installation instruction

A1. Take out anti-lightleak clips

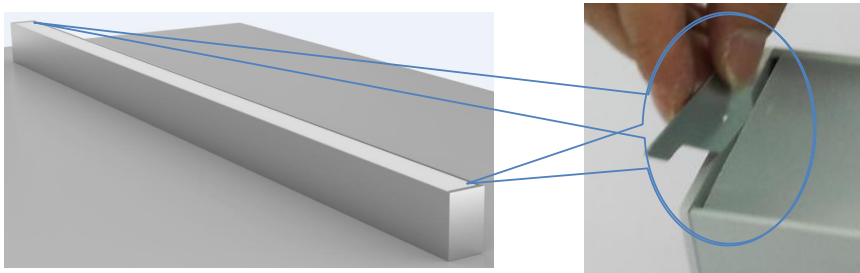

A2. Push sucker on diffuser, then pull up

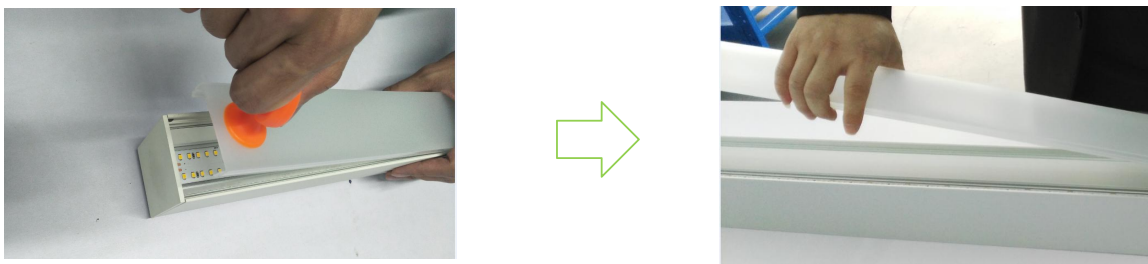

A3. Put carrier uninstallation tool into right position inside of carrier, then pull up



A4. Drill installation holes and hole for cable on ceiling according the size marked by L, input expansion pipes in installation holes.

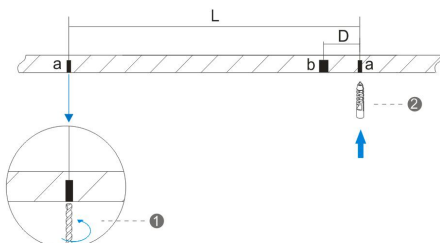

Mark:

When linear light length is 1200mm,
L=1000mm

When linear light length is 2400mm,
L=2200mm

installation hole "a"= ϕ 6mm

installation hole "b"= ϕ 10mm

hole for cable "D", the distance to installation hole "a" =50mm

12100-22 INSTALL GUIDE

A5. Fixed main profile on ceiling by screws.

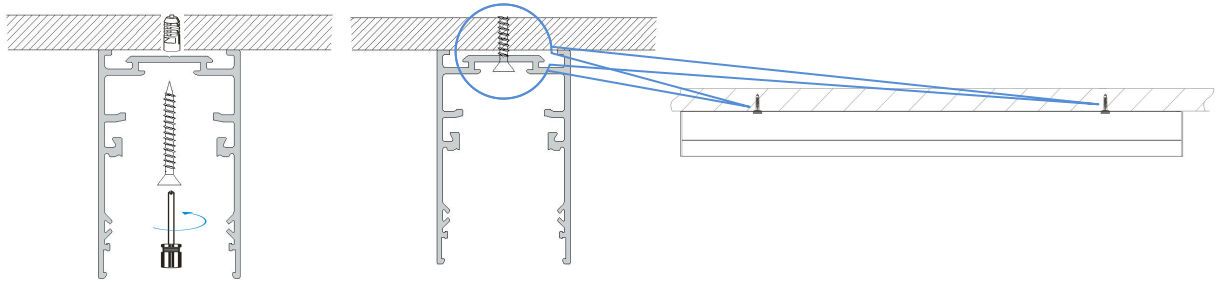

A6. Connect male-connector to female connector on carrier

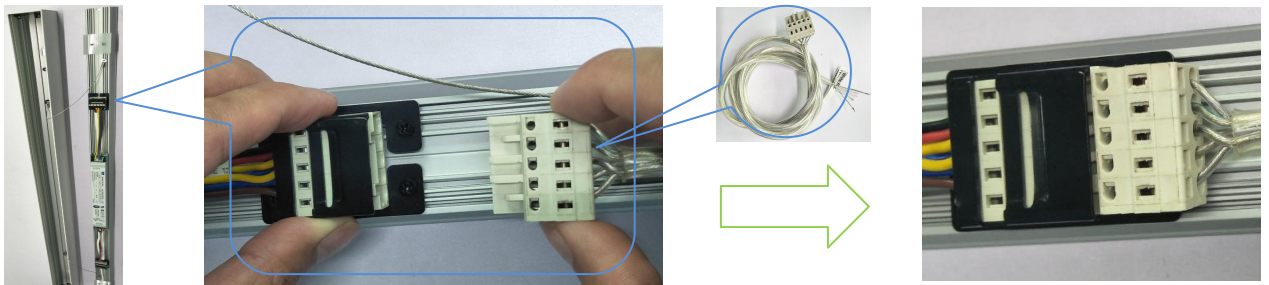

A7. Fixed AC input cable

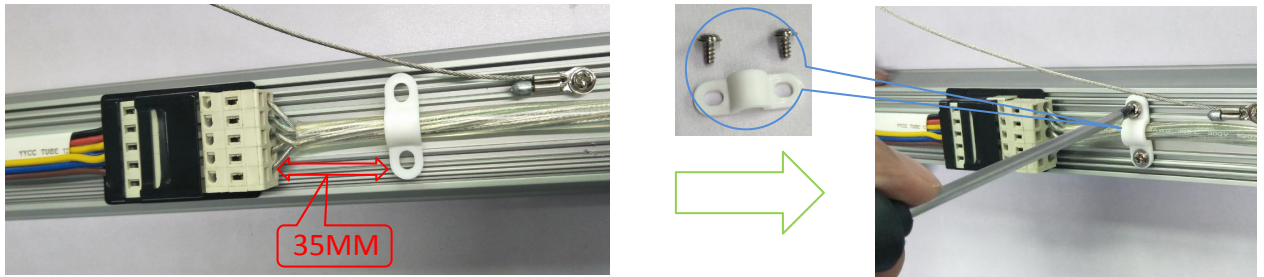

A8. Pass AC input cable through the hole on main profile

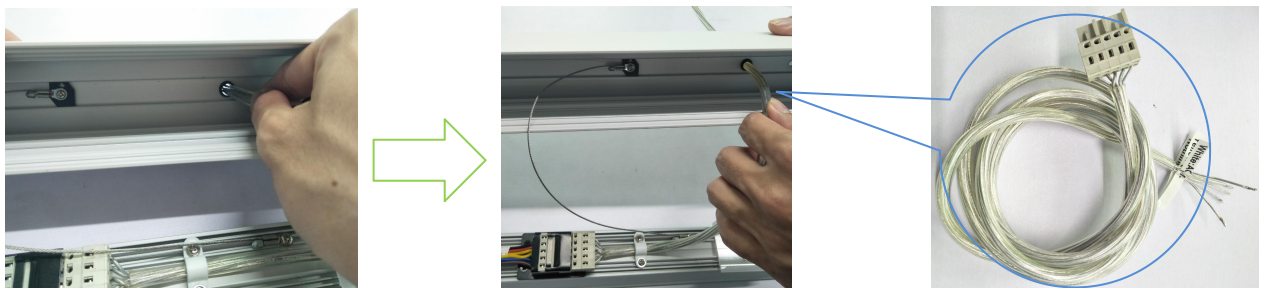

A9. Put one side of carrier on right position inside of main profile, then press carrier

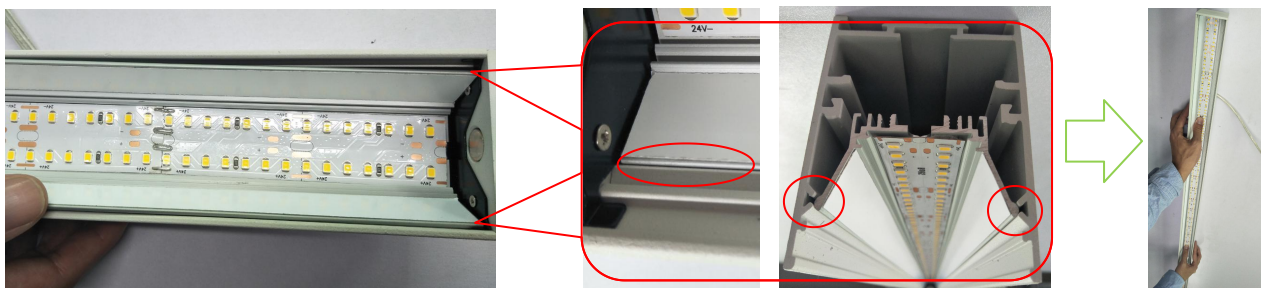

12100-22 INSTALL GUIDE

A10. Install diffusers (Keep about 1.5mm space between diffuser and end-cap on last two ends)

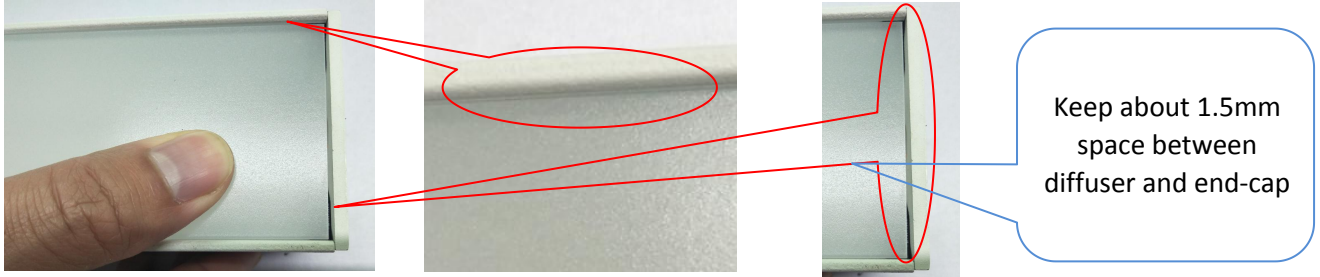

A11. Put anti-lightlead clips in the space between diffuser and end-cap.

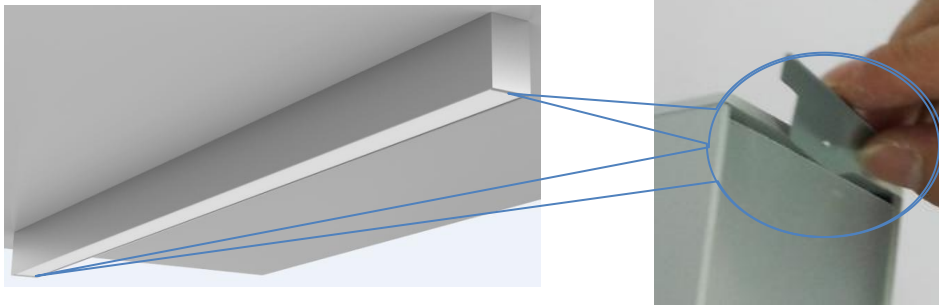

A12. Connect AC power, finish ceiling mounting.

